



Cambridge IGCSE™

CANDIDATE
NAME

--

CENTRE
NUMBER

--	--	--	--	--

CANDIDATE
NUMBER

--	--	--	--

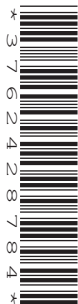

MATHEMATICS

0580/31

Paper 3 (Core)

October/November 2020

2 hours

You must answer on the question paper.

You will need: Geometrical instruments

INSTRUCTIONS

- Answer **all** questions.
- Use a black or dark blue pen. You may use an HB pencil for any diagrams or graphs.
- Write your name, centre number and candidate number in the boxes at the top of the page.
- Write your answer to each question in the space provided.
- Do **not** use an erasable pen or correction fluid.
- Do **not** write on any bar codes.
- You should use a calculator where appropriate.
- You may use tracing paper.
- You must show all necessary working clearly.
- Give non-exact numerical answers correct to 3 significant figures, or 1 decimal place for angles in degrees, unless a different level of accuracy is specified in the question.
- For π , use either your calculator value or 3.142.

INFORMATION

- The total mark for this paper is 104.
- The number of marks for each question or part question is shown in brackets [].

This document has **20** pages. Blank pages are indicated.

1 Sean is the manager of a museum.

- (a) He buys a Chinese pot costing 1200 yuan.
The exchange rate is $\$1 = 6.4$ yuan.

Work out the cost of this pot in dollars.

\$ [1]

- (b) Sean records the maximum and minimum temperatures, in $^{\circ}\text{C}$, at the museum.
Some of the results for one week are shown in the table.

Day	Mon	Tue	Wed	Thu	Fri	Sat	Sun
Maximum temperature ($^{\circ}\text{C}$)	8	12	15	14	11	7	4
Minimum temperature ($^{\circ}\text{C}$)	-5	-2	-4	-1	3		

- (i) Find the difference between the maximum temperature and the minimum temperature on Wednesday.

..... $^{\circ}\text{C}$ [1]

- (ii) The minimum temperature on Saturday was 2°C higher than the minimum temperature on Monday.

Find the minimum temperature on Saturday.

..... $^{\circ}\text{C}$ [1]

- (iii) In this week the range of temperatures was 23°C .

Find the minimum temperature on Sunday.

..... $^{\circ}\text{C}$ [1]

- (c) These are the opening times for the museum.

Monday to Friday	09 00 to 17 00
Saturday and Sunday	10 00 to 16 00

During opening hours the museum has 4 security guards working.
Each guard works a maximum of 30 hours each week.

Work out the smallest number of guards needed each week.

..... [4]

- (d) The entry price to the museum is \$18.
This price is increased by 28%.

Find the increased entry price.

\$ [2]

- 2 (a) Jian has a fair spinner in the shape of a regular hexagon. The spinner is numbered 2, 2, 3, 4, 4, 5.

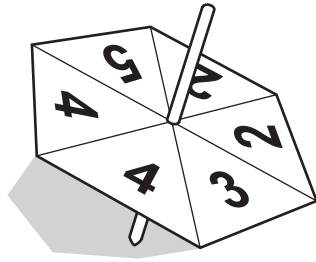

Jian spins the spinner.

Find the probability that the spinner lands on

- (i) an even number,

..... [1]

- (ii) a number less than 6,

..... [1]

- (iii) the number 1.

..... [1]

- (b) Mei has two fair square spinners, A and B. Spinner A is numbered 1, 2, 2, 4 and spinner B is numbered 3, 3, 4, 5.

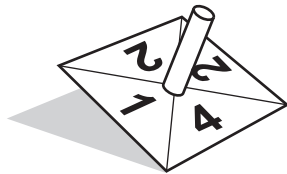

Spinner A

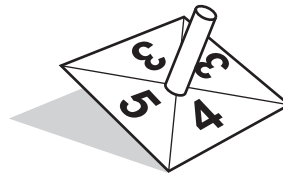

Spinner B

She spins both spinners and adds the two numbers.

- (i) Complete the table to show all the possible outcomes.

	B	3	3	4	5
A	1	4	4		
	2	5	5	6	7
	2	5	5	6	7
	4	7	7		

[2]

(ii) Use the table to write down the probability that the total is

(a) 5,

..... [1]

(b) more than 5.

..... [1]

(c) Ning has a spinner numbered 1 to 6. She spins it 50 times and her results are shown in the table.

Number on spinner	Frequency
1	15
2	12
3	9
4	5
5	2
6	7

(i) Write down the mode.

..... [1]

(ii) Find the median.

..... [1]

(iii) Work out the mean.

..... [3]

3 (a)

8 15 18 33 39 41 51 57 60 81

From this list, write down

(i) a factor of 54,

..... [1]

(ii) a multiple of 19,

..... [1]

(iii) a prime number.

..... [1]

(b) Write down the reciprocal of 64.

..... [1]

(c) (i) Write 4.81×10^{-3} as an ordinary number.

..... [1]

(ii) Write 75 000 in standard form.

..... [1]

(iii) Calculate $\frac{6.3 \times 10^2}{7 \times 10^{-3}}$.

Write your answer in standard form.

..... [2]

(d) (i)

$$\mathcal{C} = \{2, 4, 8, 16, 32, 64\}$$

$$A = \{\text{square numbers}\}$$

$$B = \{\text{cube numbers}\}$$

Use this information to complete the Venn diagram.

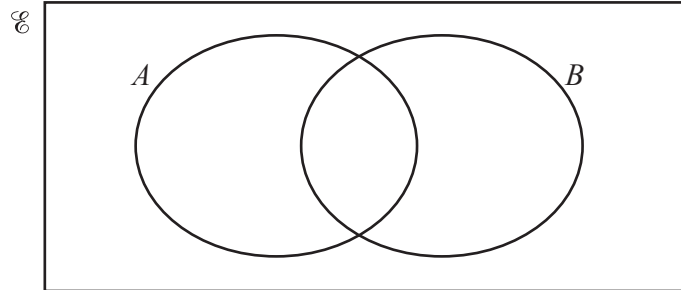

[2]

(ii) On this Venn diagram, shade the region $P \cup Q$.

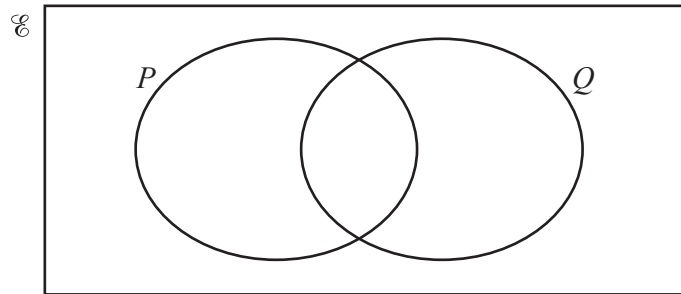

[1]

4 (a) Simplify.

$$6a - 3b + 2a - 4b$$

..... [2]

(b) Expand.

$$5(x - 3)$$

..... [1]

(c) Solve these equations.

(i) $\frac{x}{3} = 18$

$x =$ [1]

(ii) $5x + 18 = 8$

$x =$ [2]

(iii) $12x - 3 = 4x + 21$

$x =$ [2]

(d) $6^{10} \times 6^x = 6^2$

Find the value of x .

$x =$ [1]

- (e) The Fraser family and the Singh family go to the cinema.
The Fraser family buys 6 adult tickets and 2 child tickets for \$124.
The Singh family buys 3 adult tickets and 5 child tickets for \$100.

Find the price of an adult ticket and the price of a child ticket.

Adult ticket \$

Child ticket \$ [5]

5 (a) Write one hundred and twenty thousand and twenty in figures.

..... [1]

(b) Find the value of $\sqrt{3481}$.

..... [1]

(c)

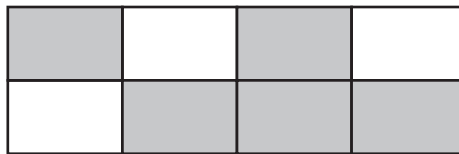

(i) Write down the fraction of the rectangle that is shaded.

..... [1]

(ii) Find the percentage of the rectangle that is **not** shaded.

.....% [1]

(d) Write these numbers in order, starting with the smallest.

$$27\% \quad \frac{5}{17} \quad 0.268 \quad \frac{7}{29}$$

..... < < < [2]
smallest

(e) Write 0.3728 correct to 1 decimal place.

..... [1]

(f) Write down the value of 19^0 .

..... [1]

(g) The height, h metres, of a tower is 128 m, correct to the nearest metre.

Complete the statement about the value of h .

..... $\leq h <$ [2]

(h) Find the highest common factor (HCF) of 126 and 180.

..... [2]

(i) Write down an irrational number with a value between 6 and 7.

..... [1]

6

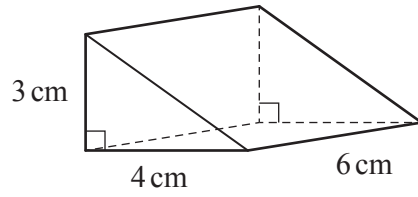
NOT TO
SCALE

The diagram shows a right-angled triangular prism.

- (a) On the 1 cm^2 grid, complete the net of the prism.
One face has been drawn for you.

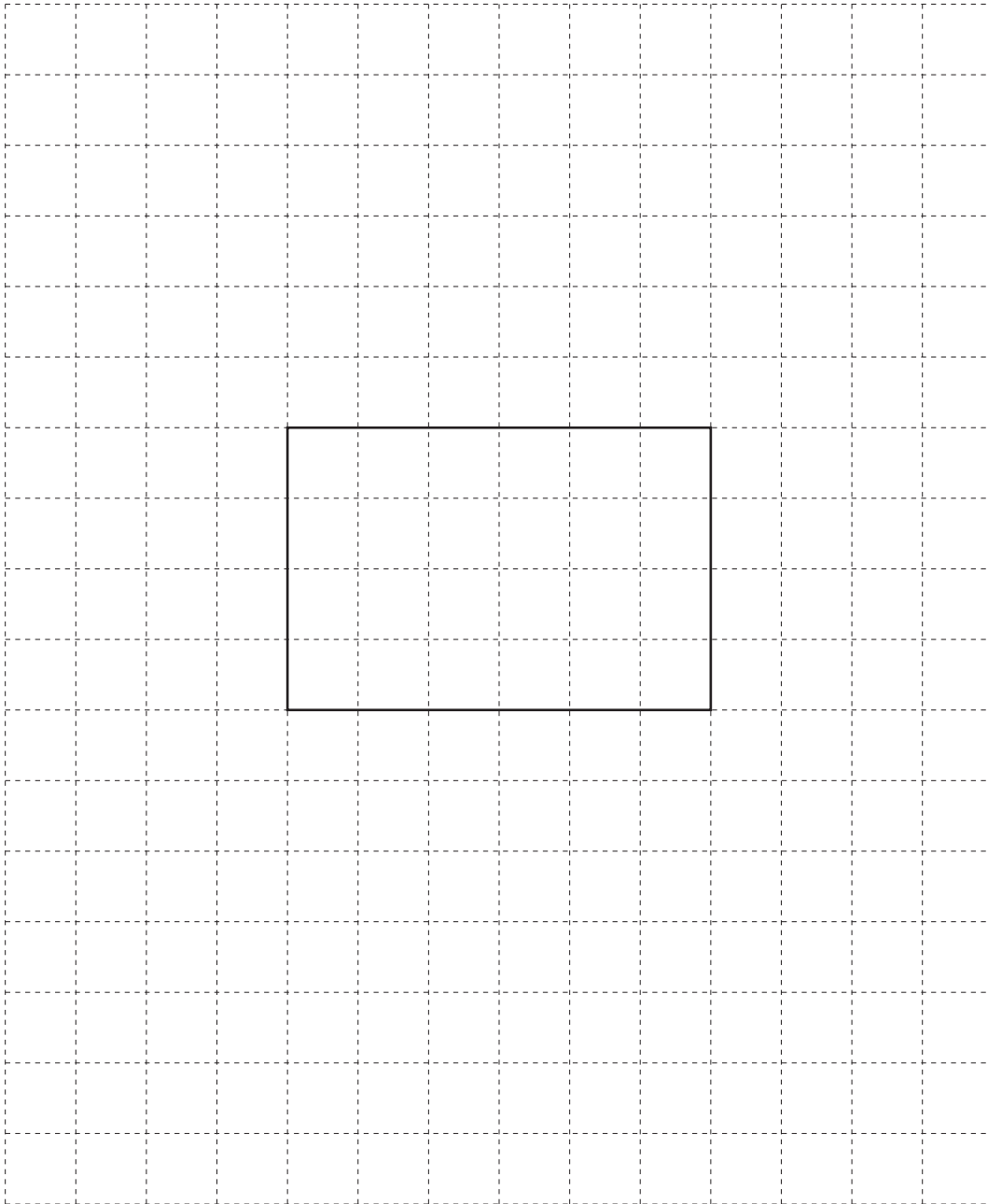

[3]

(b) Work out the surface area of the prism.

..... cm^2 [3]

(c) Work out the volume of the prism.

..... cm^3 [2]

7 (a)

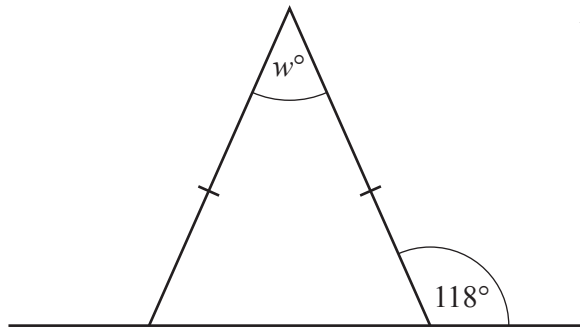

NOT TO SCALE

The diagram shows an isosceles triangle and a straight line.

Work out the value of w .

$w = \dots\dots\dots$ [2]

(b)

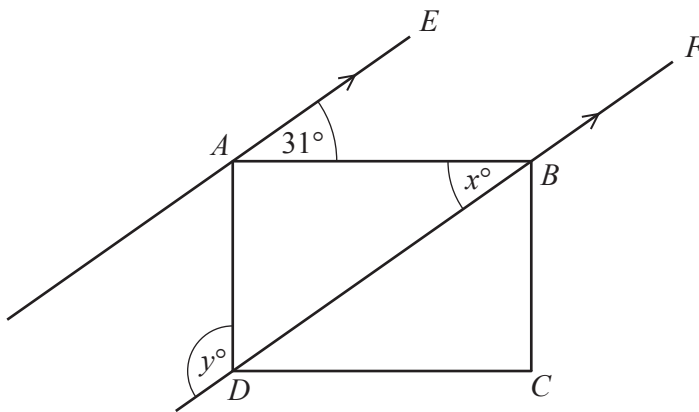

NOT TO SCALE

$ABCD$ is a rectangle.
 AE is parallel to DBF .

Find the value of x and the value of y .

$x = \dots\dots\dots$

$y = \dots\dots\dots$ [2]

(c)

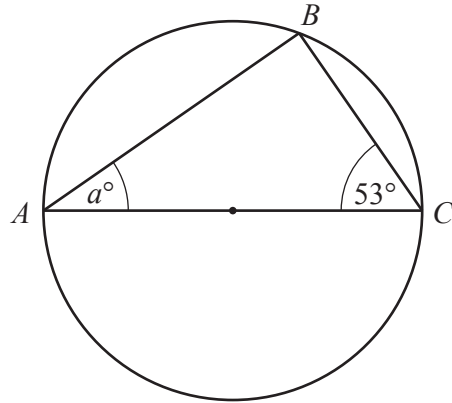

NOT TO SCALE

A , B and C are points on a circle.
 AC is a diameter of the circle.

Find the value of a .

$a = \dots\dots\dots$ [2]

(d)

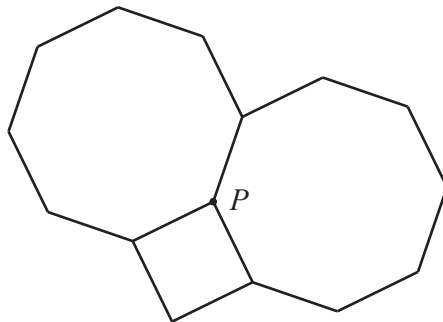

NOT TO SCALE

Two regular octagons and a square meet at point P .

Show, by calculation, that the three interior angles at P add up to 360° .

[3]

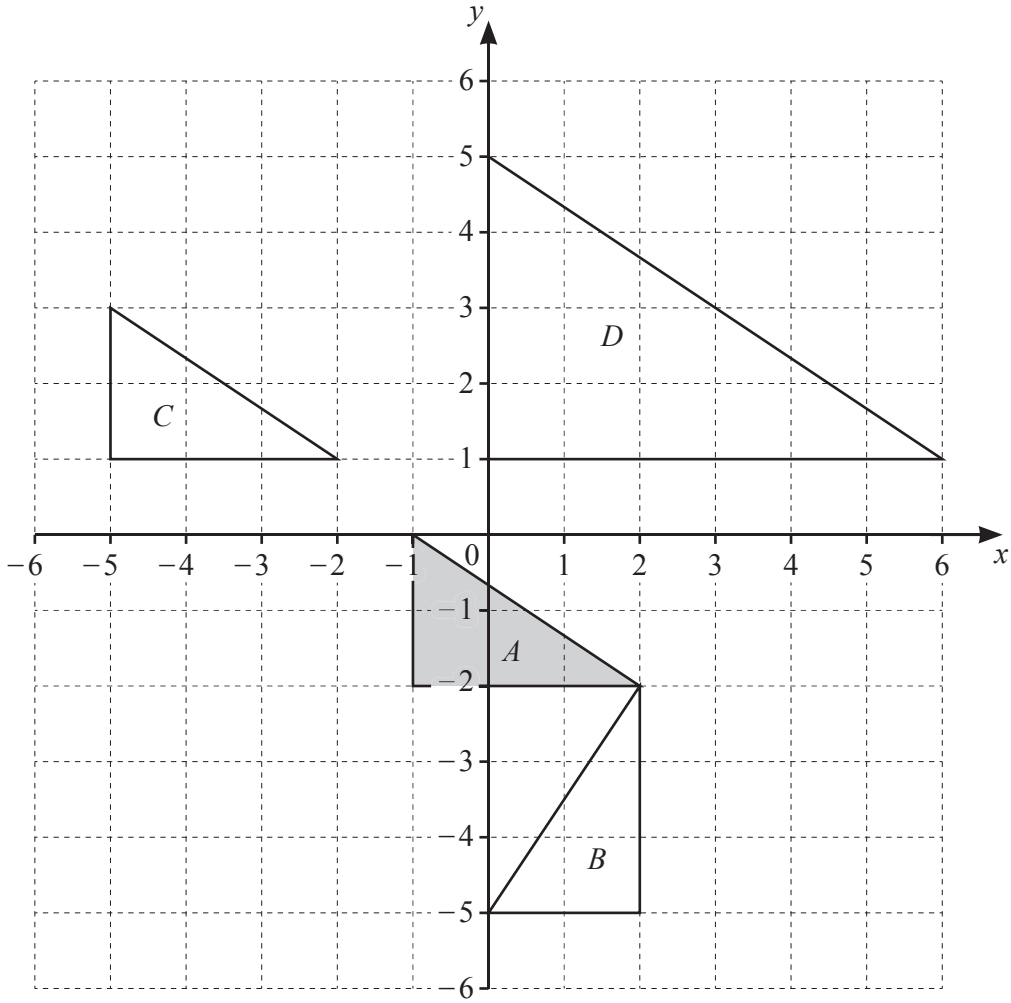

(a) Describe fully the **single** transformation that maps

(i) triangle *A* onto triangle *B*,

.....
 [3]

(ii) triangle *A* onto triangle *C*,

.....
 [2]

(iii) triangle *A* onto triangle *D*.

.....
 [3]

(b) On the grid, draw the image of triangle *A* after a reflection in the line $x = -2$. [2]

9 (a) Complete the table of values for $y = \frac{15}{x}$.

x	-5	-3	-2	-1		1	2	3	5
y				-15		15			

[3]

(b) On the grid, draw the graph of $y = \frac{15}{x}$ for $-5 \leq x \leq -1$ and $1 \leq x \leq 5$.

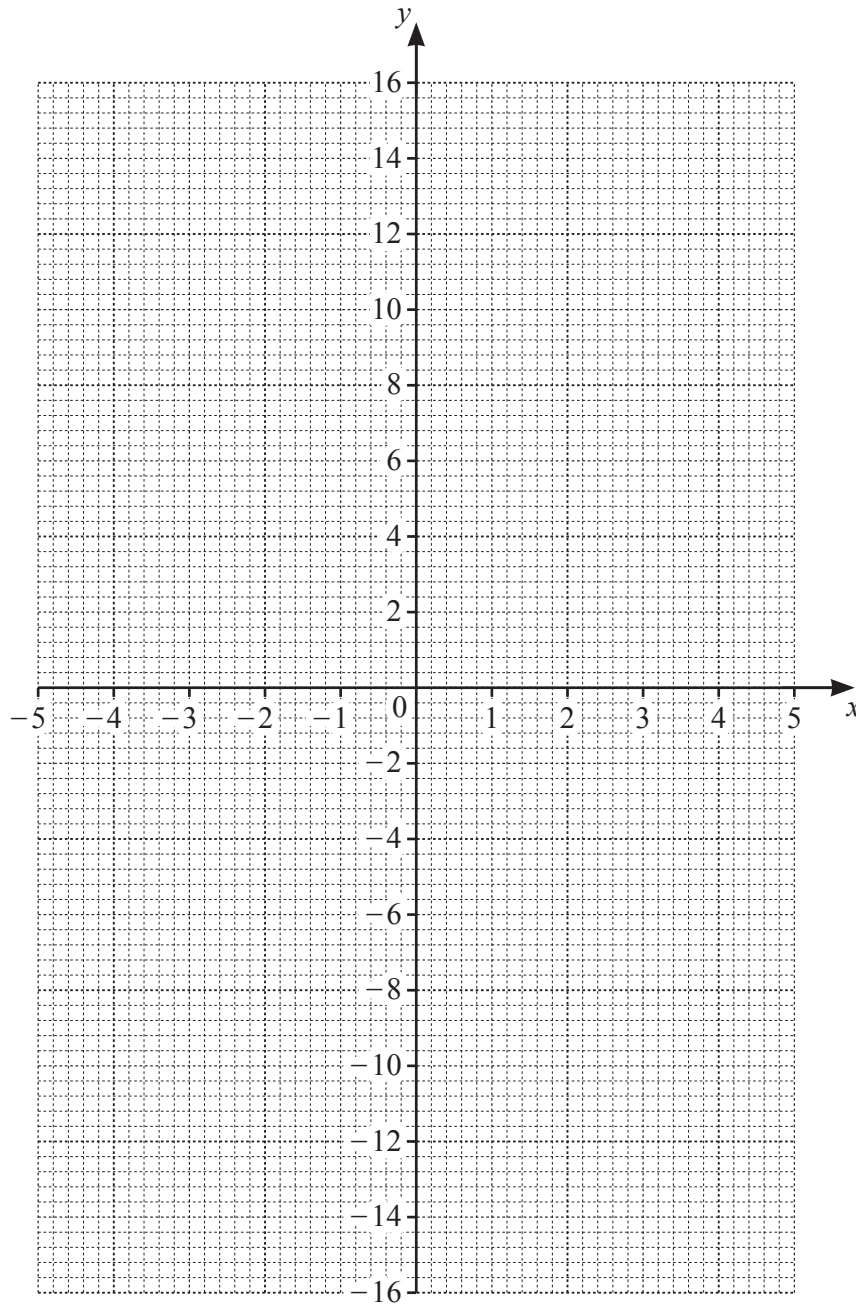

[4]

(c) On the grid, draw the line $y = 6$.

[1]

(d) Use your graph to solve $\frac{15}{x} = 6$.

$x = \dots\dots\dots$ [1]

10 (a) These are the first four terms of a sequence.

8 15 22 29

(i) Write down the next term.

..... [1]

(ii) Write down the term to term rule for continuing this sequence.

..... [1]

(iii) Find an expression for the n th term.

..... [2]

(b) Find the next term in each of these sequences.

(i) 18, 21, 26, 33, 42, ...

..... [1]

(ii) 18, 20, 24, 32, 48, ...

..... [1]

(c) Find the first three terms of the sequence with n th term $n^2 + 5n$.

..... , , [2]

BLANK PAGE

Permission to reproduce items where third-party owned material protected by copyright is included has been sought and cleared where possible. Every reasonable effort has been made by the publisher (UCLES) to trace copyright holders, but if any items requiring clearance have unwittingly been included, the publisher will be pleased to make amends at the earliest possible opportunity.

To avoid the issue of disclosure of answer-related information to candidates, all copyright acknowledgements are reproduced online in the Cambridge Assessment International Education Copyright Acknowledgements Booklet. This is produced for each series of examinations and is freely available to download at www.cambridgeinternational.org after the live examination series.

Cambridge Assessment International Education is part of the Cambridge Assessment Group. Cambridge Assessment is the brand name of the University of Cambridge Local Examinations Syndicate (UCLES), which itself is a department of the University of Cambridge.